

VETRATE PANORAMICHE



Vetrix





VETRIX *LIGHT*

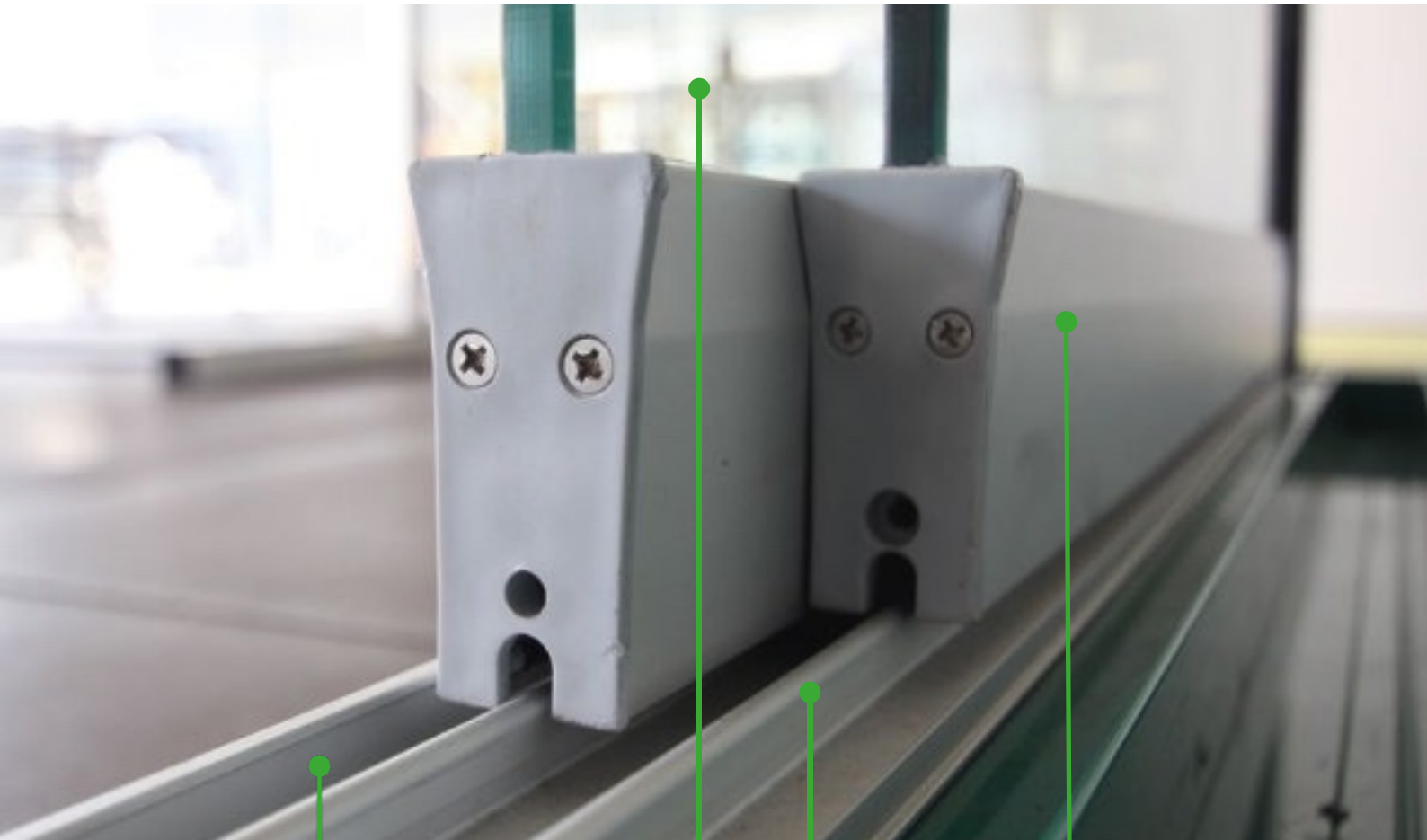

Fluidità degli scorrimenti garantita da carrellistica per esterno ad elevata portata

Assenza di profili verticali e chiusura vetro su vetro per lasciare inalterata la vista esterna

Modularità dei binari a più vie di scorrimento

I trattamenti superficiali di ossidazione e verniciatura sono eseguiti rispetto le norme Qualanod e Qualicoat

Soluzione con ante in vetro non intelaiate con movimento a scorrimento configurabile con aperture singole o multiple, ideale per la chiusura di chiostrì, pergole, gazebi, terrazzi e balconi. Realizzate con binari a 2 e 3 vie, componibili fino a 10/12. Sono dotate di carrelli con portata fino a 120 kg, regolabili in altezza fino a 7mm. È un sistema veloce e semplice da installare, connubio perfetto per tutte le strutture sia in carpenteria che composte da profili easy.



TIPOLOGIE DISPONIBILI

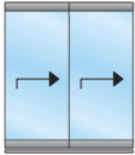

◀ Configurazione 2 ante con binario a 2 vie

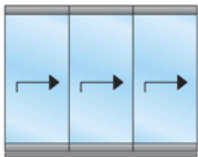

◀ Configurazione 3 ante con binario a 3 vie

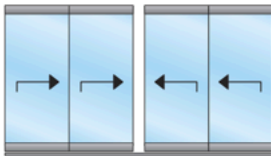

◀ Configurazione 4 ante con binario a 2 vie

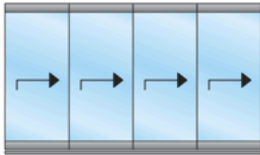

◀ Configurazione 4 ante con binario a 4 vie
(binario 2+2 vie)

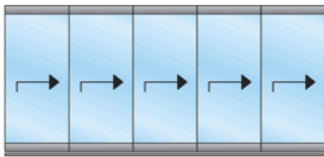

◀ Configurazione 5 ante con binario a 5 vie
(binario 3+2 vie)

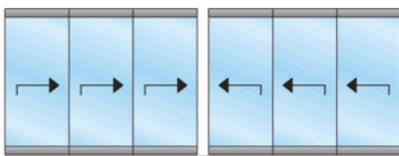

◀ Configurazione 6 ante con binario a 3 vie
(binario 3+3 vie)





ACCESSORI **VETRIX LIGHT**



DI SERIE



Maniglia adesiva trasparente

OPTIONAL



Anello in acciaio inox adesivo

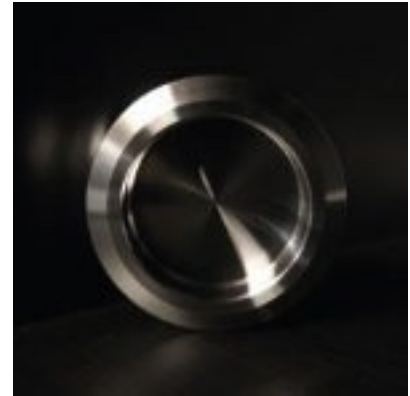

Vaschetta di trascinamento
in acciaio inox

OPTIONAL



Serratura singola con e senza contropiastra



Blocco a pedale con chiavistello
di bloccaggio

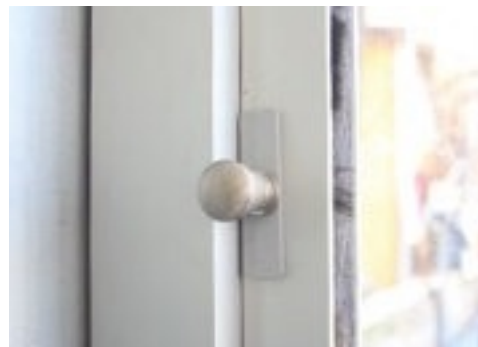

Compensatore con paletto
per bloccaggio ante

SCHEDA TECNICA **VETRIX LIGHT**



SEZIONE VERTICALE

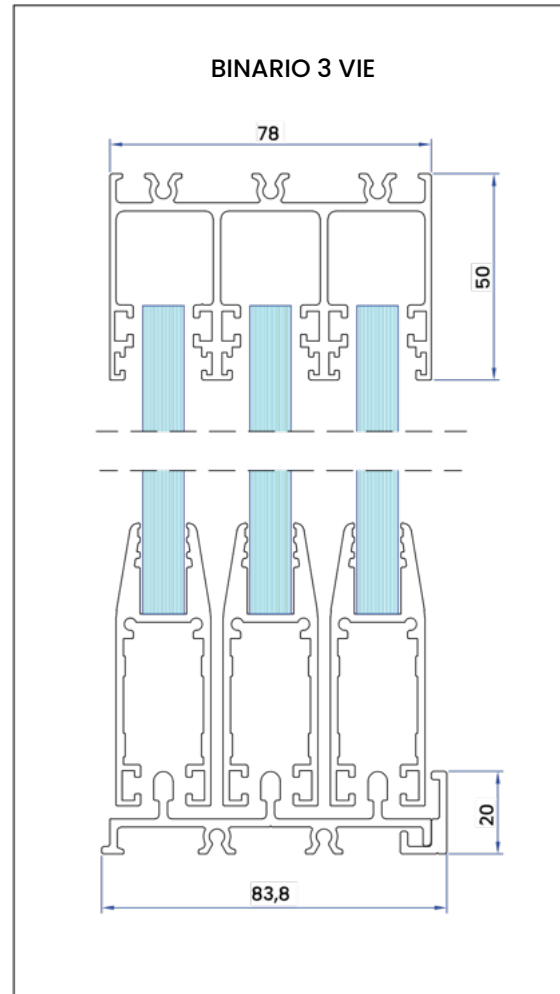
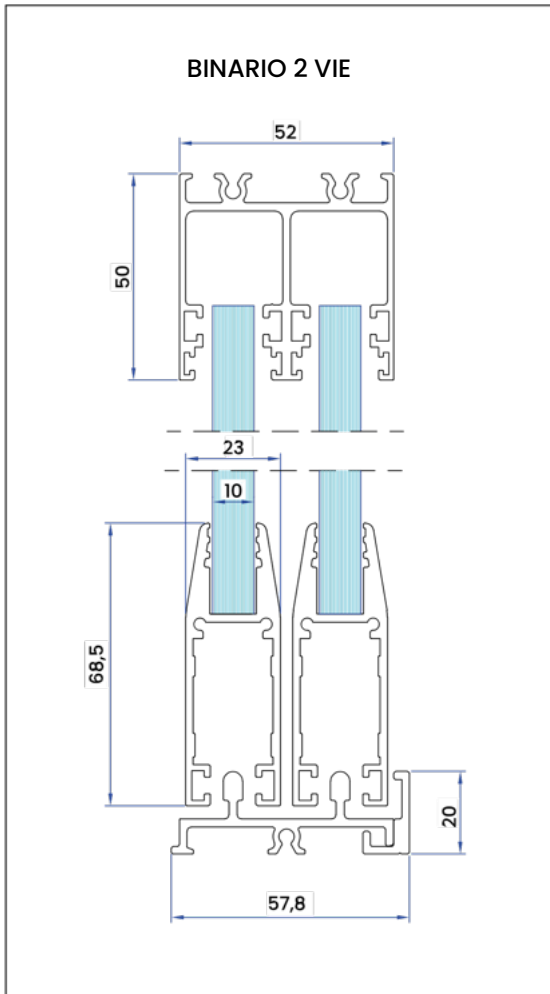

SEZIONE ORIZZONTALE STANDARD

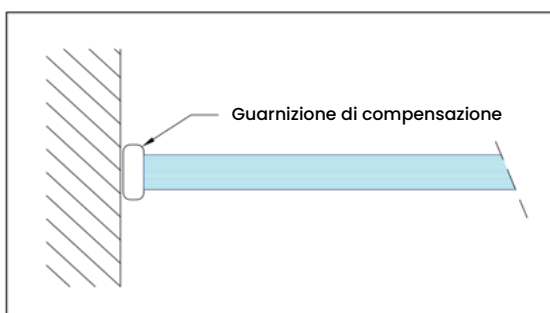

SEZIONE ORIZZONTALE / COMPENSATORE SX

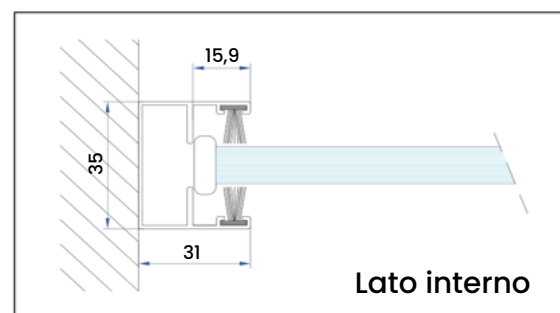



VETRIX *FLEX*

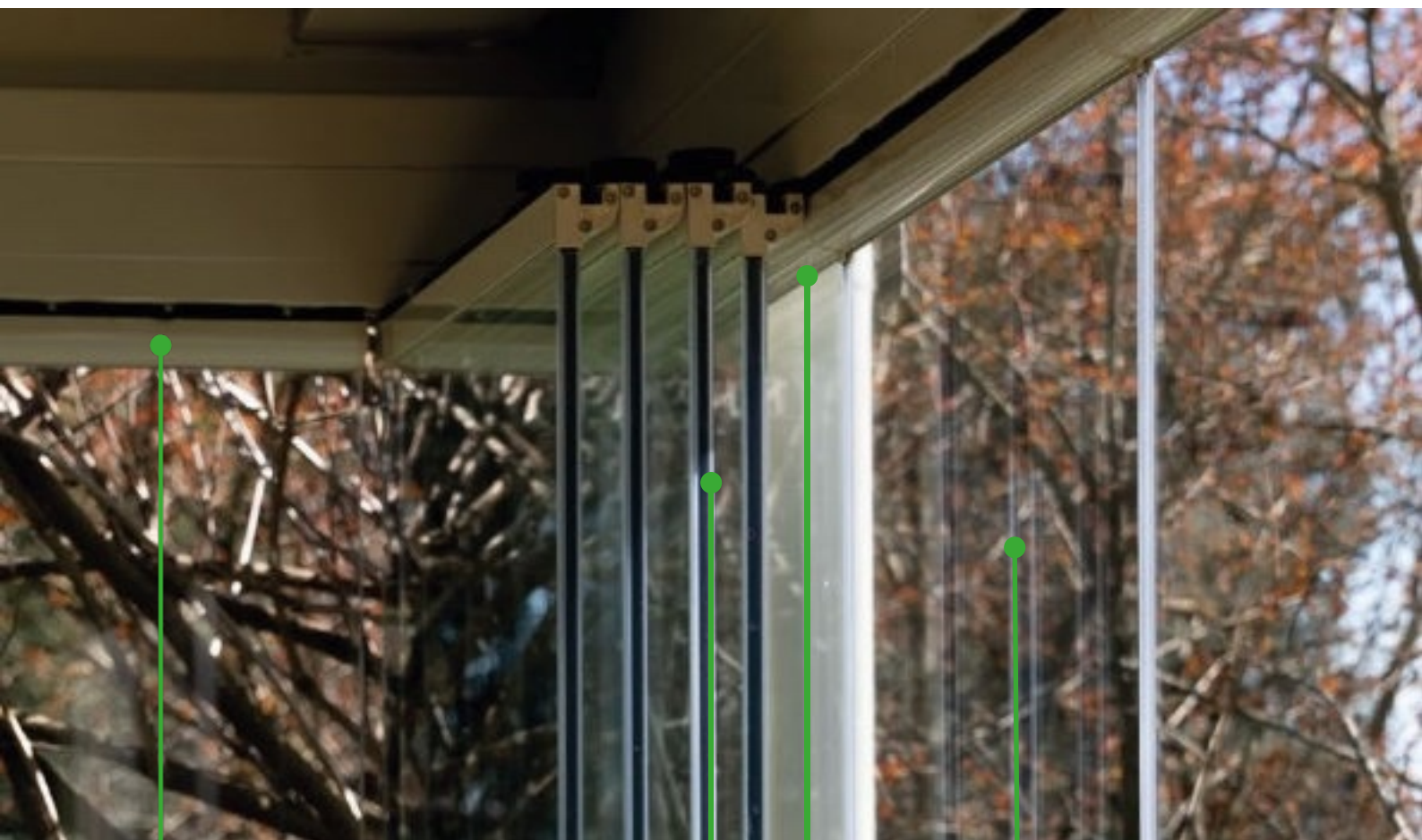

Le vetrate si aprono agevolmente grazie ad un sistema di scorrimento con cuscinetti a sfera, realizzato con tecnologie affidabili e materiali di qualità

Le ante sono dotate di guarnizioni in silicone invisibili o guarnizioni rigide, che garantiscono la perfetta chiusura e aderenza tra un pannello e l'altro

Profili in alluminio estrusi in lega EN AW 6060

I trattamenti superficiali di ossidazione e verniciatura sono eseguiti rispetto le norme Qualanod e Qualicoat

Soluzione di ante in vetro non intelaiate con movimento a scorrimento ed apertura a impacchettamento, ideale per applicazione su strutture rigide fino ad un'altezza massima di 3,10 m. La suddivisione allineata di tutta la parete trasparente permette un'apertura totale o parziale, inoltre i diversi pannelli possono essere adagiati su uno o più lati della struttura esterna in base alle specifiche esigenze.

TIPOLOGIE DISPONIBILI

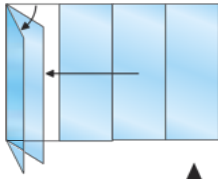

Configurazione standard apertura SX singola interna pomo singolo

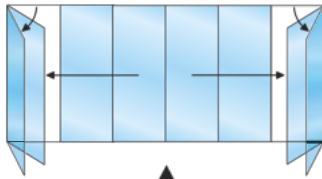

Configurazione standard apertura doppia SX/DX interna; pomo singolo per le porte di ingresso.

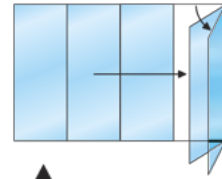

Configurazione standard apertura DX singola interna pomo singolo

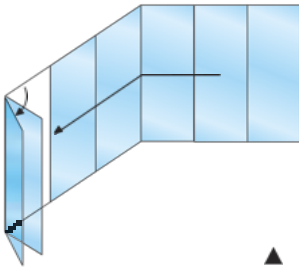

Configurazione con angolo 90° Tuttovetro; apertura SX singola interna pomo singolo

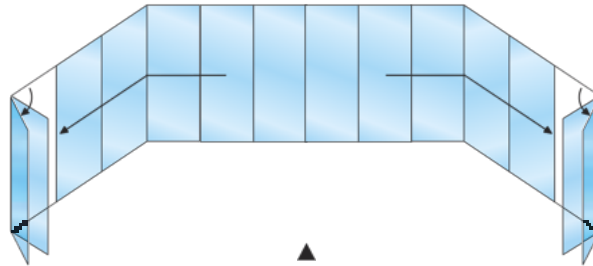

Configurazione con angolo 90° Tuttovetro apertura doppia SX/DX interna; pomo singolo per le porte di ingresso.

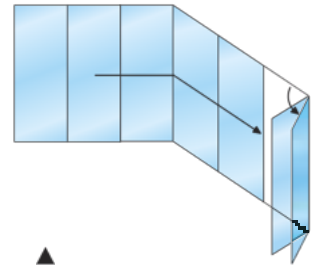

Configurazione con angolo 90° Tuttovetro; apertura DX singola interna pomo singolo





ACCESSORI **VETRIX FLEX**



DI SERIE

OPTIONAL

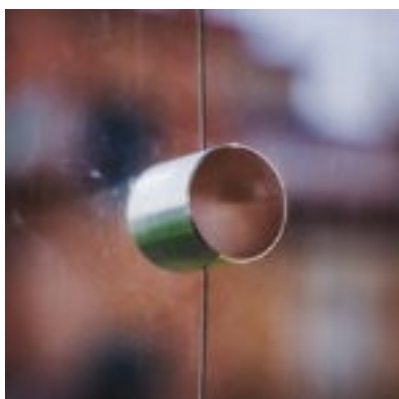

Pomello con corda in acciaio



Maniglia doppia satinata
con serratura e contropiastra

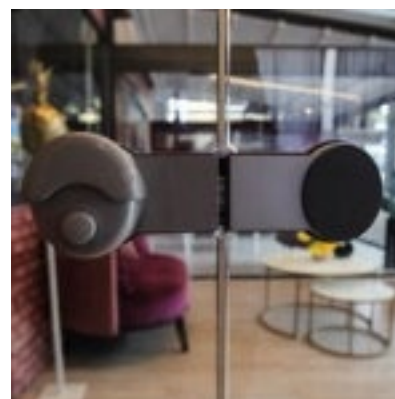

Premi e apri Meroni

OPTIONAL



Blocco ante

SCHEDA TECNICA **VETRIX FLEX**

SEZIONE VERTICALE CON
BINARIO INFERIORE STANDARD

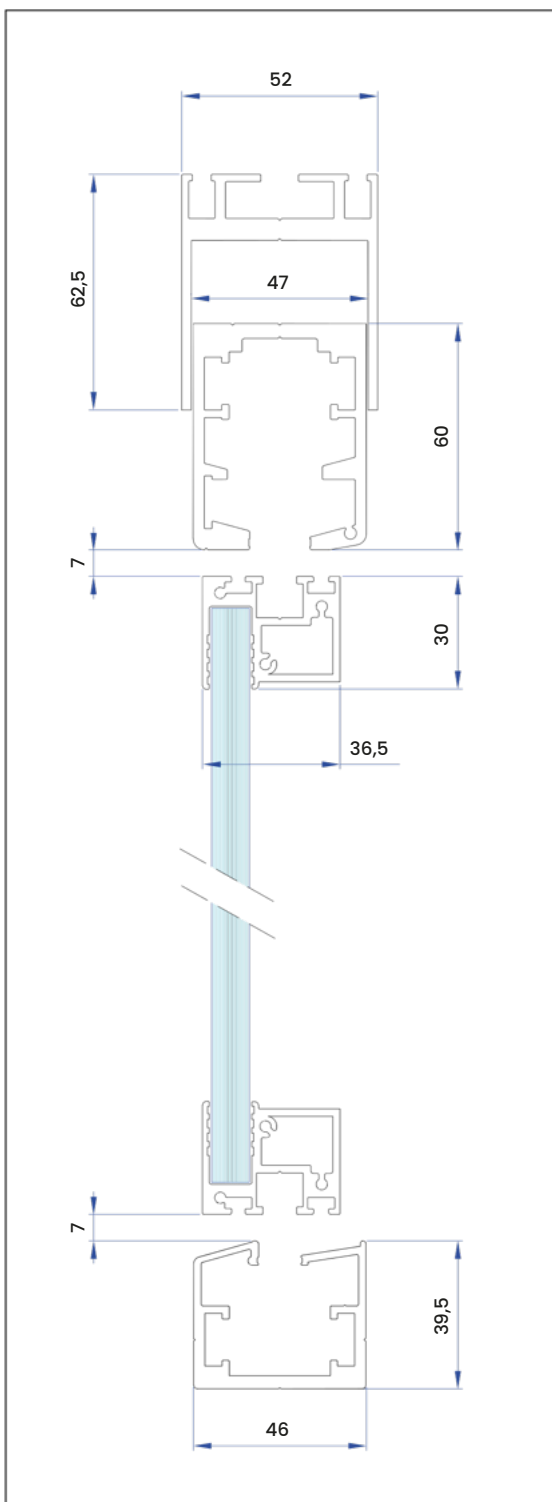

POSA INCASSATA CON
BINARIO INFERIORE STANDARD

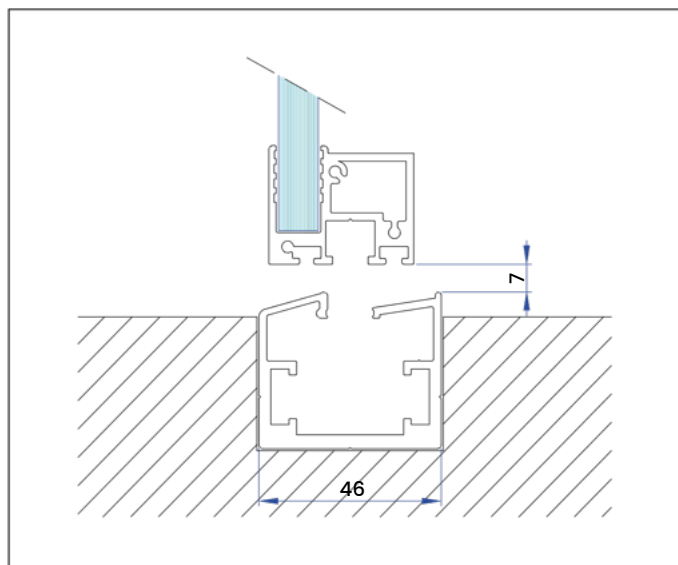



SCHEDA TECNICA

VETRIX FLEX

SEZIONE ORIZZONTALE
STANDARD

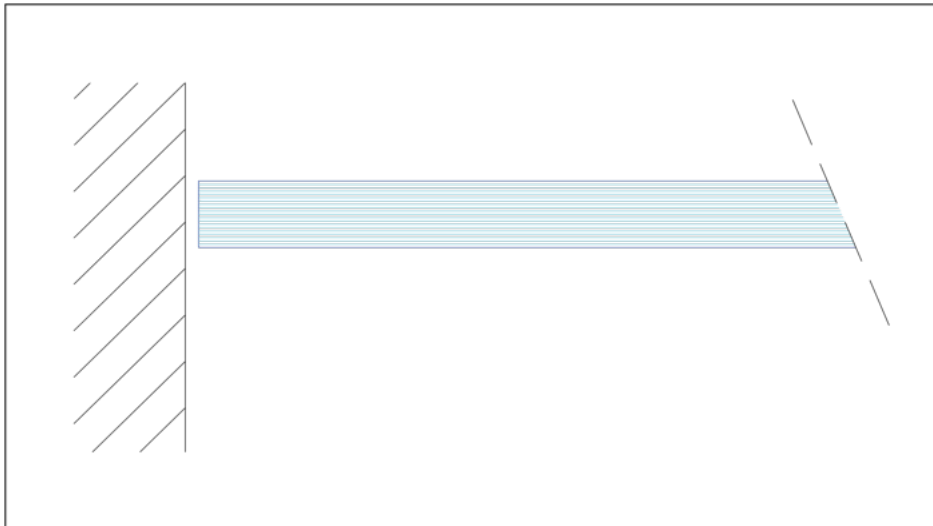

SEZIONE ORIZZONTALE
/ COMPENSATORE SX

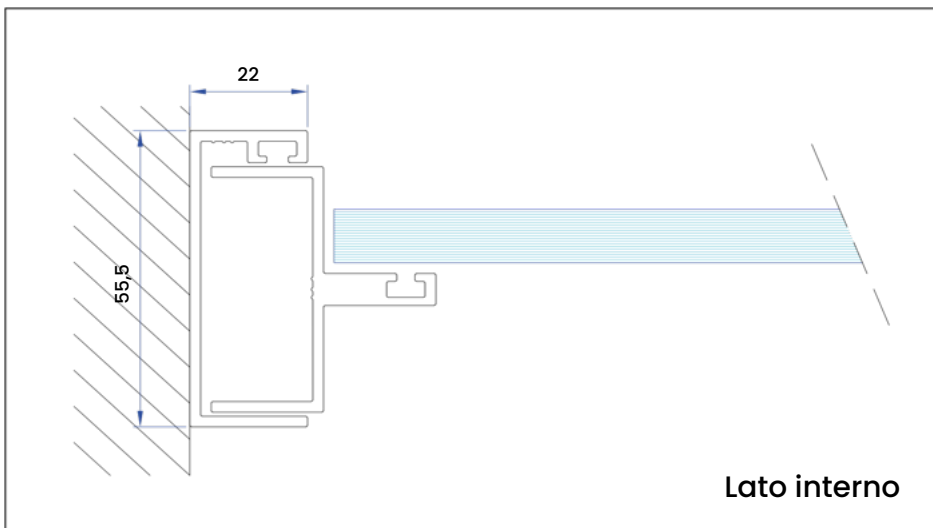

FINITURE

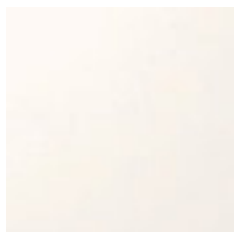

H62
9010 R TX | BIANCO

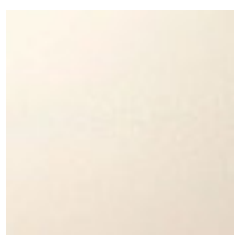

H63
1013 R TX | AVORIO

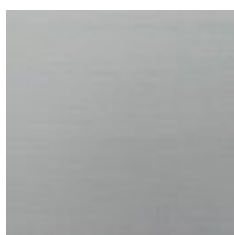

H75
OX AS | OSSIDATO ARGENTO

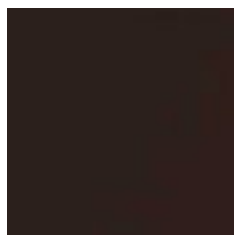

H93
8017 R TX | MARRONE

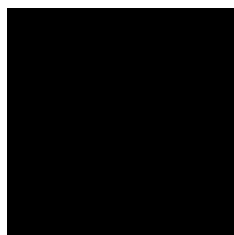

H53
9005 R TX | NERO



VETRI

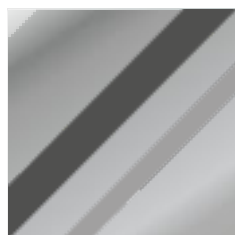

V01
VETRO TEMPRATO 10MM



V02
VETRO STRATIFICATO 55.2
TEMPRATO E INDURITO





800 029139



info@tapfi.it



TAPLUX

 **MADE IN ITALY**